

**DS-2DE5232W-AE(T5)**

**5-inch 2 MP 32 × Powered by DarkFighter Network Speed Dome**

## AcuSense

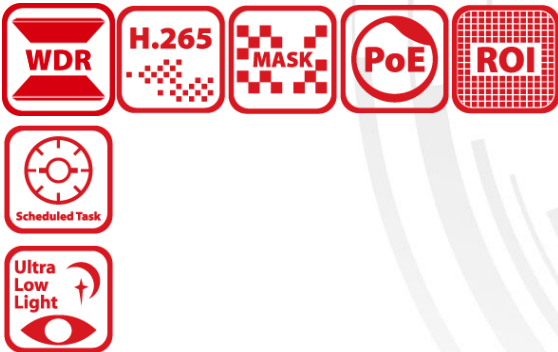

Hikvision DS-2DE5232W-AE(T5) 2 MP 32 × Network Speed Dome adopts 1/2.8" progressive scan CMOS chip. With the 32 × optical zoom lens, the camera offers more details over expansive areas.

This series of cameras can be widely used for wide ranges of high-definition, such as rivers, roads, railways, airports, squares, parks, scenic spots, and venues, etc.

- 1/2.8" Progressive Scan CMOS
- High quality imaging with 2 MP resolution
- Excellent low-light performance with powered-by-DarkFighter technology
- 32 × optical zoom and 16 × digital zoom provide close up views over expansive areas
- WDR, HLC, BLC, 3D DNR, defog, regional exposure, regional focus
- 24 VAC & PoE (IEEE 802.3at)
- Efficient H.265+/H.265 compression technology
- Water and dust resistant (IP66) and vandal resistant (IK10)



## ▪ DORI

The DORI (detect, observe, recognize, identify) distance gives the general idea of the camera ability to distinguish persons or objects within its field of view.

It is calculated based on the camera sensor specification and the criteria given by EN 62676-4: 2015.

DORI	Detect	Observe	Recognize	Identify
Definition	25 px/m	63 px/m	125 px/m	250 px/m
Distance (Tele)	1600.0 m (5249.3 ft)	634.9 m (2083.1 ft)	320.0 m (1049.9 ft)	160.0 m (524.9 ft)

## ▪ Specification

Camera		
Image Sensor	5	1/2.8" Progressive Scan CMOS
Min. Illumination	4	Color: 0.005 Lux @ (F1.6, AGC ON); Black/White: 0.001 Lux @ (F1.6, AGC ON)
Shutter Speed		1 s to 1/30,000 s
Slow Shutter		Yes
Day & Night		IR cut filter
Zoom	1	32 × optional, 16 × digital
Max. Resolution		1920 × 1080
Lens		
Focus		Auto, semi-auto, manual
Focal Length		4.8 mm to 153.6 mm
Zoom Speed		Approx. 4.8 s
FOV		Horizontal field of view: 50.8° to 2.6° (wide-tele), Vertical field of view: 29.4° to 1.5° (wide-tele), Diagonal field of view: 57.4° to 3° (wide-tele)
Aperture		Max. F1.6
PTZ		
Movement Range (Pan)	1	360°
Movement Range (Tilt)	1	-5° to 90° (auto flip)
Pan Speed		Pan speed: configurable from 0.1° to 250°/s; preset speed: 300°/s
Tilt Speed		Tilt speed: configurable from 0.1° to 150°/s, preset speed 200°/s
Proportional Pan		Yes
Presets		300
Patrol Scan		8 patrols, up to 32 presets for each patrol
Pattern Scan		4 pattern scans
Power-off Memory		Yes
Park Action		Preset, pattern scan, patrol scan, auto scan, tilt scan, random scan, frame scan, panorama scan
3D Positioning		Yes
PTZ Status Display		Yes
Preset Freezing		Yes
Scheduled Task		Preset, pattern scan, patrol scan, auto scan, tilt scan, random scan, frame scan, panorama scan, dome reboot, dome adjust, aux output

Video	
Main Stream	<a href="#">2,3</a> 50 Hz: 50 fps (1920 × 1080, 1280 × 960, 1280 × 720) 60 Hz: 60 fps (1920 × 1080, 1280 × 960, 1280 × 720)
Sub-Stream	50 Hz: 25 fps (704 × 576, 640 × 480, 352 × 288) 60 Hz: 30 fps (704 × 480, 640 × 480, 352 × 240)
Third Stream	50 Hz: 25 fps (1920 × 1080, 1280 × 960, 1280 × 720, 704 × 576, 640 × 480, 352 × 288) 60 Hz: 30 fps (1920 × 1080, 1280 × 960, 1280 × 720, 704 × 480, 640 × 480, 352 × 240)
Video Compression	<a href="#">7,9</a> Main stream: H.265+/H.265/H.264+/H.264 Sub-stream: H.265/H.264/MJPEG Third stream: H.265/H.264/MJPEG
Video Bit Rate	32 Kbps to 16 Mbps
H.264 Type	Baseline profile/Main profile/High profile
H.265 Type	Main profile
Scalable Video Coding (SVC)	H.264 and H.265 encoding
Region of Interest (ROI)	8 fixed regions for each stream
Audio	
Audio Compression	G.711/G.722.1/G.726/MP2L2/PCM
Audio Bit Rate	64 Kbps (G.711)/16 Kbps (G.722.1)/16 Kbps (G.726)/32-192 Kbps (MP2L2)
Audio Sampling Rate	8 kHz/16 kHz/32 kHz/48 kHz
Environment Noise Filtering	Yes
Network	
Network Storage	NAS (NFS, SMB/CIFS), auto network replenishment (ANR)
Protocols	<a href="#">10</a> IPv4/IPv6, HTTP, HTTPS, IEEE 802.1X, Qos, FTP, SMTP, UPnP, SNMP, DNS, DDNS, NTP, <a href="#">14</a> RTSP, RTCP, RTP, TCP/IP, UDP, IGMP, ICMP, DHCP, PPPoE, Bonjour, Websocket, Websockets, ONVIF <a href="#">8</a>
API	Open Network Video Interface (Version 19.12, Profile S, Profile G, Profile T), ISAPI, SDK, <a href="#">16</a>
Simultaneous Live View	Up to 20 channels
User/Host	Up to 32 users; 3 user levels: administrator, operator, and user
Security	Password protection, complicated password, HTTPS encryption, IEEE 802.1X authentication (EAP-TLS, EAP-LEAP, EAP-MD5), watermark, IP address filter, basic and digest authentication for HTTP/HTTPS, control timeout settings, security audit log, TLS 1.2, host authentication (MAC address)
Client	iVMS-4200, HikCentral Pro, Hik-Connect
Web Browser	IE11, Chrome57+, Firefox52+, Safari11+
Image	
Day/Night Switch	Day, Night, Auto, Schedule
Image Enhancement	BLC, HLC, 3D DNR
Wide Dynamic Range (WDR)	120 dB
Defog	Digital Defog
Regional Exposure	Yes
Regional Focus	Yes
Image Settings	Saturation, brightness, contrast, sharpness, gain, and white balance adjustable by client software or web browser
Image Parameters Switch	Yes

Privacy Mask		24 programmable polygon privacy masks, mask color or mosaic configurable
SNR		> 52 dB
<b>Interface</b>		
Ethernet Interface	11	1 RJ45 10M/100M Base-T 8self-adaptive Ethernet port
On-board Storage	15	Built-in memory card slot, support microSD/SDHC/SDXC card, up to 256 GB
Alarm		2 inputs, 1 output
Audio		1 input (line in), max. input amplitude: 2-2.4 vpp, input impedance: 1 K $\Omega$ $\pm$ 10%; 1 output (line out), line level, output impedance: 600 $\Omega$
Reset		Yes
<b>Event</b>		
Basic Event	6	Motion detection, video tampering alarm, exception, alarm input and output
Smart Event		line crossing detection, intrusion detection, region entrance detection, region exiting detection, unattended baggage detection, object removal detection, audio exception detection
Alarm Linkage		Upload to FTP/NAS/memory card, notify surveillance center, send email, trigger alarm output, trigger recording, and PTZ actions (such as preset, patrol scan, pattern scan)
<b>Deep Learning Function</b>		
Face Capture		Yes
<b>General</b>		
Operating Condition	13	-30 $^{\circ}$ C to 65 $^{\circ}$ C (-22 $^{\circ}$ F to 149 $^{\circ}$ F). Humidity 90% or less (non-condensing)
Power		24 VAC, Max. 20 W; PoE (IEEE 802.3at) 10
Material		Metal
Dimension		$\varnothing$ 220 mm $\times$ 280 mm ( $\varnothing$ 8.66" $\times$ 11.02")
Weight		Approx. 3.0 kg (6.61 lb.)
<b>Approval</b>		
EMC		FCC (47 CFR Part 15, Subpart B); CE-EMC (EN 55032: 2015, EN 61000-3-2:2019, EN 61000-3-3:2013+A1:2019, EN 50130-4: 2011 +A1: 2014); RCM (AS/NZS CISPR 32: 2015); IC (ICES-003: Issue 7); KC (KN 32: 2015, KN 35: 2015)
Safety	17	UL (UL 62368-1); CB (IEC 62368-1:2014+A11); CE-LVD (EN 62368-1:2014/A11:2017); BIS (IS 13252(Part 1):2010/IEC 60950-1: 2005); LOA (IEC/EN 60950-1)
Environment		CE-RoHS (2011/65/EU); WEEE (2012/19/EU); Reach (Regulation (EC) No 1907/2006)
Protection	12	IP66 (IEC 60529-2013), IK10 (IEC 62262:2002), TVS 6000V lightning protection, surge protection and voltage transient protection

## ▪ Available Model

DS-2DE5232W-AE(T5)

## ▪ Typical Application

Hikvision products are classified into three levels according to their anti-corrosion performance. Refer to the following description to choose for your using environment.

This model has NO SPECIFIC PROTECTION.

Level	Description
Top-level protection	Hikvision products at this level are equipped for use in areas where professional anti-corrosion protection is a must. Typical application scenarios include coastlines, docks, chemical plants, and more.
Moderate protection	Hikvision products at this level are equipped for use in areas with moderate anti-corrosion demands. Typical application scenarios include coastal areas about 2 kilometers (1.24 miles) away from coastlines, as well as areas affected by acid rain.
No specific protection	Hikvision products at this level are equipped for use in areas where no specific anti-corrosion protection is needed.

▪ **Dimension**

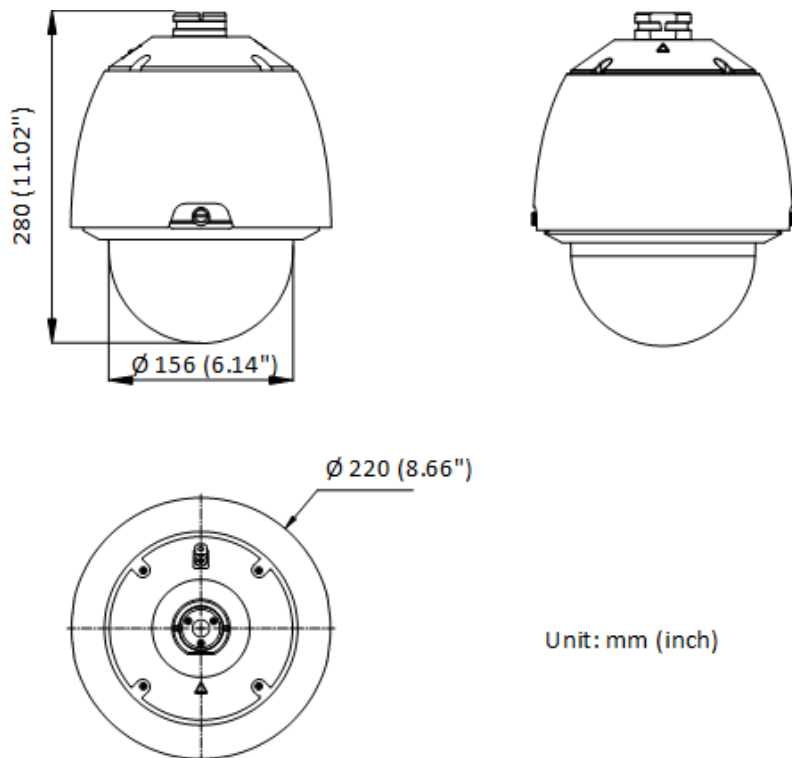



















▪ **Accessory**

▪ **Included**



▪Optional

<b>DS-1681ZJ</b>	<b>DS-1604ZJ</b>	<b>DS-1604ZJ-corner</b>	<b>DS-1663ZJ</b>	<b>DS-1604ZJ-pole</b>
				
<b>DS-1619ZJ</b>	<b>DS-1681ZJ-2</b>	<b>DS-1667ZJ</b>	<b>DS-1673ZJ</b>	<b>DS-1661ZJ</b>
				
<b>DS-1604ZJ-BOX-CORNER</b>	<b>DS-1100KI</b>	<b>DS-1005KI</b>	<b>DS-1604ZJ-box</b>	<b>DS-1682ZJ</b>
				
<b>DS-1662ZJ</b>	<b>DS-1604ZJ-BOX-POLE</b>	<b>DS-1660ZJ</b>		
				

Distributed by

**HIKVISION®****Headquarters**

No.555 Qianmo Road, Binjiang District,  
Hangzhou 310051, China  
T +86-571-8807-5998  
overseasbusiness@hikvision.com

**Hikvision USA**  
T +1-909-895-0400  
sales.usa@hikvision.com

**Hikvision Australia**  
T +61-2-8599-4233  
salesau@hikvision.com

**Hikvision India**  
T +91-22-28469900  
sales@pramahikvision.com

**Hikvision Canada**  
T +1-866-200-6690  
sales.canada@hikvision.com

**Hikvision Thailand**  
T +662-275-9949  
sales.thailand@hikvision.com

**Hikvision Europe**  
T +31-23-5542770  
sales.eu@hikvision.com

**Hikvision Italy**  
T +39-0438-6902  
info.it@hikvision.com

**Hikvision Brazil**  
T +55 11 3318-0050  
Latam.support@hikvision.com

**Hikvision Turkey**  
T +90 (216)521 7070- 7074  
sales.tr@hikvision.com

**Hikvision Malaysia**  
T +601-7652-2413  
sales.my@hikvision.com

**Hikvision UK & Ireland**  
T +01628-902140  
sales.uk@hikvision.com

**Hikvision South Africa**  
Tel: +27 (10) 0351172  
sale.africa@hikvision.com

**Hikvision France**  
T +33(0)1-85-330-450  
info.fr@hikvision.com

**Hikvision Kazakhstan**  
T +7-727-9730667  
nikia.panfilov@hikvision.ru

**Hikvision Vietnam**  
T +84-974270888  
sales.vt@hikvision.com

**Hikvision UAE**  
T +971-4-4432090  
salesme@hikvision.com

**Hikvision Singapore**  
T +65-6684-4718  
sg@hikvision.com

**Hikvision Spain**  
T +34-91-737-16-55  
info.es@hikvision.com

**Hikvision Tashkent**  
T +99-87-1238-9438  
uzb@hikvision.ru

**Hikvision Hong Kong**  
T +852-2151-1761  
info.hk@hikvision.com

**Hikvision Russia**  
T +7-495-669-67-99  
saleru@hikvision.com

**Hikvision Korea**  
T +82-(0)31-731-8817  
sales.korea@hikvision.com

**Hikvision Poland**  
T +48-22-460-01-50  
info.pl@hikvision.com

**Hikvision Indonesia**  
T +62-21-2933759  
Sales.Indonesia@hikvision.com

**Hikvision Colombia**  
sales.colombia@hikvision.com